

EXTENDED FEMALE MULLION
5000-SP2

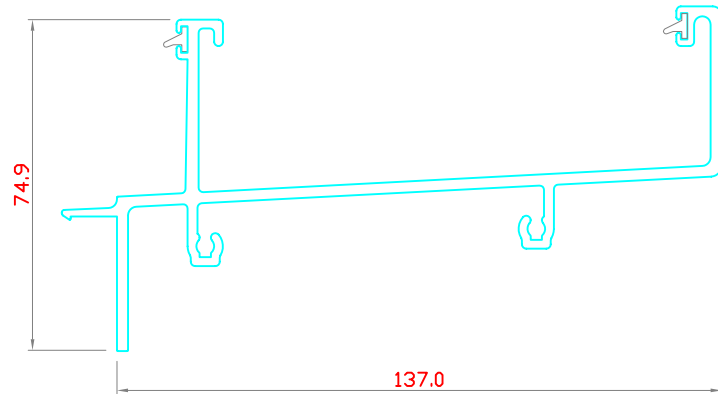

EXTENDED MALE MULLION
5000-SP1



STACKHEAD FRAME
5000-SPS03

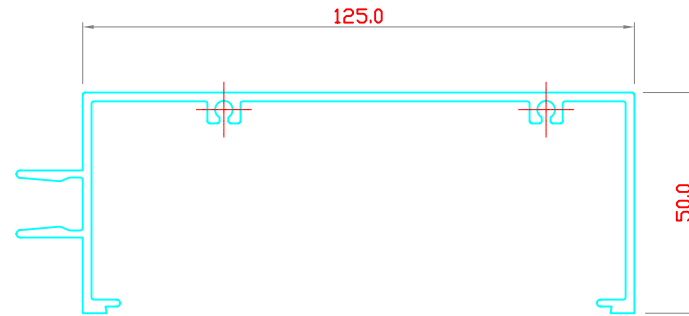

HEAD/ TRANSOM FRAME
5000-SPT01

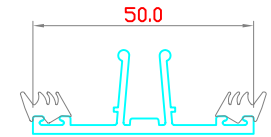

TRANSOM CAP
5000-SP16

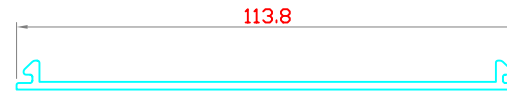

COVER ADAPTOR
5000-SPT02

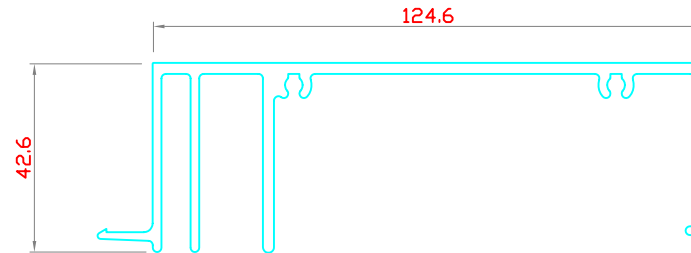

STACKSILL FRAME
5000-SPS01

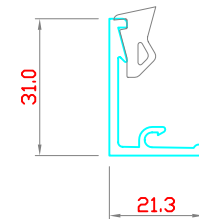

GLAZING BEAD
5000-SPS02

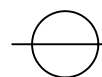

SPECIAL SECTIONS



Seapac Philippines, Inc.

4th Floor 115 Y - L Building
Rufino Corner Salcedo Street,
Legazpi Village, Makati City

Phone: (632) 892-8437
Facsimile: (632) 893-9867

Subject: 5800 SERIES - COMMERCIAL STRUCTURALLY UNITIZED CURTAINWALL

Drawn by: RTA	Date:	Drawing No.	REVISION:
---------------	-------	-------------	-----------

Checked by: CS	Scale: 1 : 2	A4	5800 / CSU/ 001	-
----------------	--------------	----	-----------------	---

SEAPAC PHILIPPINES, INC. THESE DESIGN DRAWING AND THE COPYRIGHT THERE IN ARE PROPERTY OF SEAPAC PHILIPPINES INC. AND MUST NOT BE DIVULGED REPRODUCED OR COPIED WITHOUT WRITTEN PERMISSION.